

FILED FOR RECORD: 3-27 19 84 at 2:00 o'clock P M
 DULY RECORDED: 3-29 19 84 at 9:00 o'clock A M
 INSTRUMENT NO. _____ GRACE BOSTICK, TYLER CO. CLK.
 BY: Jean Phillips Deputy
 JEAN PHILLIPS

TYLER COUNTY COMMISSIONER'S COURT
 SPECIAL MEETING
 MARCH 16, 1984----10:00 A. M.

VOL 009 PAGE 39

A Special Meeting of the Commissioner's Court met on Friday, March 16, 1984, at 10:00 A. M. All members being present. The meeting was opened with prayer by Commissioner James R. Jordan.

A motion was made by Commissioner Riley and seconded by Commissioner Lowe to approve the bid received from Knapp Ford Sales, Inc. for a new Truck for Pct. #1, to be equipped with a Gallion bed and without air. Time Warrants will be issued for this truck. Purchase price for this type equipped truck is \$14,899.00, with the installed Gallion bed price at an extra \$3,608.87, amounting to a total price of \$18,507.87. All voted yes and none no. At this time, a motion was made by Commissioner Lowe and seconded by Commissioner Mahan to approve the bid received from Knapp Ford Sales, Inc. for a new Truck for Pct. #2, to be equipped with a Gallion bed and with air, to be paid for with funds from Pct. #2. Purchase price for this type equipped truck is \$16,053.37, with the installed Gallion bed priced at an extra \$3,608.87, amounting to a total price of \$19,662.24. All voted yes and none no. Also, at this time, a motion was made by Commissioner Jordan and seconded by Commissioner Riley to table any decision to be made concerning the purchase of a new truck for Pct. #4, until further information could be obtained. All voted yes and none no. Bids received for these three (3) trucks are listed as follows:

Knapp Ford Sales, Inc.--1984 F700-Hydraulic Brakes-----	\$14,899.00
Gallion and/or Heil Brand Bed-----	3,608.87
Total Price - Each Truck -----	<u>18,507.87</u>
Knapp Ford Sales, Inc.--1984 F700-Air Brakes-----	16,053.37
Gallion and/or Heil Brand Bed-----	3,608.87
Total Price--Each-Truck-----	<u>19,662.24</u>
Allison Chevrolet, Inc.--1984 C7D042-Hydraulic Brakes-----	15,456.94
Installed Bed-----	3,695.00
Total Price - Each Truck -----	<u>19,151.94</u>
Allison Chevrolet, Inc.--1984 C7D042-Air Brakes-----	20,235.35
Installed Bed-----	3,695.00
Total Price - Each Truck-----	23,930.35
A & M Motor Co., Inc.--1984 GMC, 7000 Series-Hydraulic	
Brakes-----	15,900.00
Heil Bed -----	3,650.00
Total Price - Each Truck-----	<u>19,550.00</u>
A & M Motor Co., Inc.--1984 GMC, Same Specifications exdept	
different transmission and wheels-----	14,650.00
Heil Bed-----	3,650.00
Total Price - Each Truck-----	<u>18,300.00</u>
A & M Motor Co., Inc.--1984 GMC, Same Specifications except	
different brakes, transmission, and wheels-----	16,800.00
Heil Bed-----	3,690.00
Total Price - Each Truck-----	<u>20,450.00</u>
A & M Motor Co., Inc.--1984 GMC, Same Specifications except	
different transmission, brakes, wheels-----	16,375.00
Heil Bed-----	3,650.00
Total Price - Each Truck-----	<u>20,025.00</u>

See Attached.

A motion was made by Commissioner Riley and seconded by Commissioner Lowe to approve renewing the land lease for the Indian Ball Park with International Paper Co. for another year. All voted yes and none no. See Attached.

A motion was made by Commissioner Riley and seconded by Commissioner Lowe to approve extending the County insurance for the Courthouse for another year with Evans Insurance Company, Woodville, Texas. All voted yes and none no.

A motion was made by Commissioner Riley and seconded by Commissioner Lowe to table until a later date to be set by Commissioners Court any decision concerning the County Extension's monthly report. All voted yes and none no.

A motion was made by Commissioner Mahan and seconded by Commissioner Jordan to approve paying bills, as submitted by County Auditor Ann Nichol, with the exception of tabling any decision to be made concerning Spell's Cleaners' statement. This bill covered cleaning uniforms for the Sheriff's Department, and it was decided that Auditor Nichol should contact Sheriff Fowler and discuss the matter with him. All voted yes and none no. See Attached.

A motion was made by Commissioner Riley to adopt a resolution concerning State funding for County roads, but for lack of a second by other Commissioners, Commissioner Riley withdrew his motion. At this time, a motion was made by Commissioner Mahan and seconded by Commissioner Lowe to table until a later date any decision to be made on the resolution. All voted yes and none no.

There being no further business, the meeting adjourned.

SIGNED: Allen Sturrock Allen Sturrock, County Judge
Maxie L. Riley Maxie L. Riley, Comm. Pct. #1
H. K. Lowe H. K. Lowe, Comm. Pct. #2
Jerry Mahan Jerry Mahan, Comm. Pct. #3
James R. Jordan James R. Jordan, Comm. Pct. #4
 ATTEST: Grace Bostick Grace Bostick, County Clerk

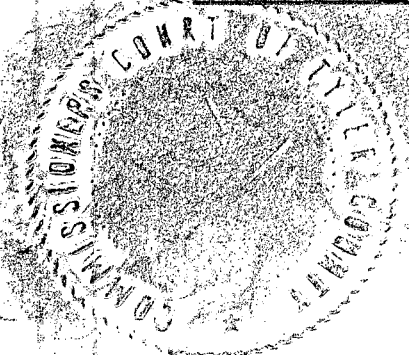

NOTICE OF TIME AND PLACE OF MEETING

COMMISSIONERS COURT
TYLER COUNTY, TEXAS

THIS NOTICE POSTED IN ACCORDANCE WITH V. A. T. S. - ART. 6252-17

NOTICE is hereby given that Commissioners Court will hold it's
Special meeting on FRIDAY, MARCH 16 1984 at 9:00 A.M.
in the Commissioners Courtroom, First Floor, Tyler County Courthouse.

A G E N D A

1. DISCUSS PERSONNEL WITH OUTSIDE AUDITOR IN CLOSED SESSION.



Allen Sturrock, County Judge
Tyler County, Texas

NO. _____ TIME: 9:45 ^{AM}

MAR 13 1984

GRACE BOSTICK, COUNTY CLERK
TYLER COUNTY, TEXAS

BY: 

NOTICE OF TIME AND PLACE OF MEETING

COMMISSIONERS COURT
TYLER COUNTY, TEXAS

THIS NOTICE POSTED IN ACCORDANCE WITH V. A. T. S. - ART. 6252-17

NOTICE is hereby given that Commissioners Court will hold it's

Special meeting on FRIDAY, MARCH 16 1984 at 10:00 A.M.

in the Commissioners Courtroom, First Floor, Tyler County Courthouse.

A G E N D A

1. APPROVE PAYING BILLS FROM AUDITORS OFFICE.
2. APPROVE COUNTY EXTENSION MONTHLY REPORT.
3. CONSIDER PURCHASE OF TRUCKS FROM OPENED BIDS.
4. RENEWAL OF COUNTY INSURANCE FOR COURTHOUSE.
5. RENEW LAND LEASE FOR INDIAN BALL PARK WITH INTERNATIONAL PAPER COMPANY.
6. RESOLUTION CONCERNING STATE FUNDING FOR COUNTY ROADS.

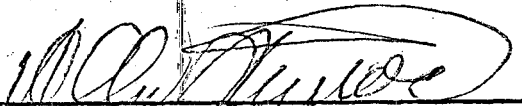

Allen Sturrock, County Judge
Tyler County, Texas

NO. _____ TIME: 9:45 ^{AM} _{PM}

MAR 13 1984

GRACE BOSTICK, COUNTY CLERK
TYLER COUNTY, TEXAS

BY: Bonnie Gregory



KNAPP FORD SALES, Inc.

104 Pine Street

Telephone 713/ 283-2526 or 283-2515

WOODVILLE, TEXAS 75979

3-12-1984

VOL 009 PAGE 41

Tyler County Commissioner's Court
Tyler County Court House
Woodville, Texas 75979

Subject: Bid Three (3) 1984 F700 Trucks for PCTS #I, #II & #IV
per specifications of Tyler County. (Attached)

Knapp Ford is pleased to offer the following bids on the attached
described trucks.

1984 F700 to Tyler County Specifications With Hydraulic Brakes	\$14,899.00 Ea. ①
1984 F700 to Tyler County Specifications with Air Brakes	\$16,053.37 Ea. ②

Subject: Bid on Dump Beds meeting Specifications of Tyler County.

Two (2) Makes of Beds are available for the same cost. Both are 10' Beds.

- (1). GALLION Bed (See enclosed brochures)
- (2). HEIL Brand Name Bed

Bed installed on the above described trucks \$3,608.87 Ea.

Respectfully submitted,

Thomas C. Knapp

Thomas C. Knapp,
President

Accept 1
Accept 2

H Bed

Specifications for (3) Three 1984 F700 Trucks for Pcts. #I, #II and #IV per specifications of Tyler County

18,500 REAR END: REAR AXLE 19,000# Spicer M190 2 Speed: Recommended 7:17/9:77 Rear Axle Ratio which will provide a Limiting speed of 59.8 MPH at an Engine governed speed of 3600 RPM. This provides full hauling capacity at Lawful Highway Speeds.

10 X 20 TIRES ON/OFF HIGHWAY--12 PLY: 10 X 20-12 PLY Front & Rear with On/Off Highway Tread on Rear.

10 HOLE BUD WHEELS: 10 Hole Bud Wheels will be 20 X 7.5.

366 Cu. INCH ENGINE OR LARGER: 370 Cubic Inch Engine

5 SPEED TRANSMISSION; 2 SPEED AXLE: Spicer 5 Speed Transmission 4054-1 is recommended. This is a wide ratio transmission which will provide a shifting pattern which is generally accepted as a standard pattern when coupled with the Spicer M190, 19000#, 2 Speed Rear Axle.

HYDRAULIC BRAKES: Hydraulic Brakes are recommended by the factory for this type of truck. The new hydraulic system provides the same stopping distance as air system brakes. This is a split system which provides good stopping ability even with a partial failure. The hydraulic fluid is boosted by a pump on the trucks engine with an electric pump to provide back up pressure in case the trucks engine is not operating. The parking brake is spring set by a dash mounted control knob very similar to setting air brakes.

REGULAR SIZE CAB HEATER ONLY: Standard equipment conventional cab with standard trim: Full Width Bench Seat, Vinyl, Tan or Charcoal.

ALL INSTRUMENTS: Instruments will include Tachometer showing engine RPM, Ammeter water temp, Oil pressure and Fuel Guage

HEAVY DUTY COOLING SYSTEM: Extra large Radiator and Fan with Heavy Duty Clutch

REINFORCED FRAME: A reinforced inverted L Frame with an 18.0 section at 50,000# per Sq. In. providing a resistance bending moment of 900,000.00

23,000 REAR SPRINGS: Springs ground rating of 23,340#

3 LEAF AUXILIARY SPRINGS: Standard Equipment

POWER STEERING: Standard Equipment

DUAL 6 X 16 MIRRORS: Standard Equipment meets I.C.C. regulations.

50 GAL SADDLE TANK: May be mounted on either left or right hand side. I.C.C. approved.

9000# FRONT AXLE: 9000# Front Axle

** BRAKES AIR: OPTIONAL EQUIPMENT, DOES NOT ALTER ANY OTHER SPECIFICATION

Ford Truck brake-through!

Ford's commitment to excellence is certainly demonstrated by the new split-hydraulic brake system. A highly advanced system that's now standard on all Ford F-600 through FT-800 Series trucks. The new system has many features of air brakes—at standard hydraulic brake prices.

Powered by hydraulic pressure not vacuum, brakes are operable immediately at engine start. Front disc brakes are fade-resistant. New rear drum brakes are designed to run cool within the dual wheels.

Ford's new rear drum brakes have long-life linings $\frac{3}{4}$ " thick. Quick visual wear check. Fewer parts, simplified servicing.

Spring-set parking brake—like air. Push-pull knob sets the rear service brakes under spring pressure—like air brakes. And they can be released as soon as the engine starts. The need for a driveline parking brake is eliminated. Revolutionary! But Ford's new brake system is thoroughly job proven.

Hydraulic power. Power is supplied by a hydraulic pump, dual master cylinder and booster. The Ford system has been proven in School Bus and F-Series service since 1980. The vacuum booster, reserve tank and lines required

Because the primary power source is pressurized fluid, not air or vacuum, parking brake release and brakes are instantly available at engine start up. Brake performance is not affected by altitude or rapid number of applications. The booster has an integral electric backup motor. This motor is automatically actuated to provide braking power if the engine stalls, or the hydraulic pump flow drops too low for any reason. A brake warning light and buzzer alert the driver in the event of primary pump malfunction.

Rear drum brakes. Husky drum rear brakes are designed to run cool behind the dual rear wheels. And a new tapered brake block was developed

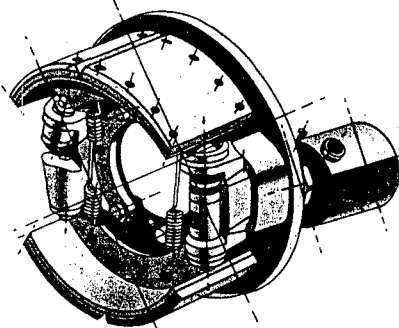

with at least 27% more usable lining volume to provide longer lining life. Self-adjusting, of course.

Front disc brakes. Ford engineers selected front disc brakes for stability and fade resistance during braking. In addition, semi-metallic linings molded to steel pads last up to five times longer than previous front drum brake linings. And Ford pads can be easily inspected through a large opening in the top of the caliper. Disc brake service simplicity—only five parts compared to up to 12 for drums—and longer lining life reduce maintenance time and expense.

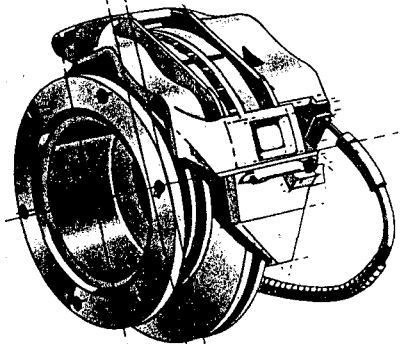

Hydraulic brakes with tandem axles. Ford's unique hydraulic brake system also permits its use in tandem axle trucks—an industry exclusive in 1984.

Lower parts inventory. Extensive parts commonality in the Ford system reduces inventory requirements. For example, left and right hand disc brake calipers and jounce hoses are interchangeable.

Job right and job ready. Positive spring-set parking brake action with no driveline slack, previously limited to air brakes, provides the stability needed to handle booms, buckets and cherry pickers while parked with outriggers. For fire trucks and other emergency vehicles, Ford's positive instantaneous engine-on, parking brake release and brakes available system saves important seconds. There's no wait for air pressure to build up.

Air brakes optional. For tractor service, requiring air for trailer brakes, Ford naturally offers full-air brakes on 700 and larger series.

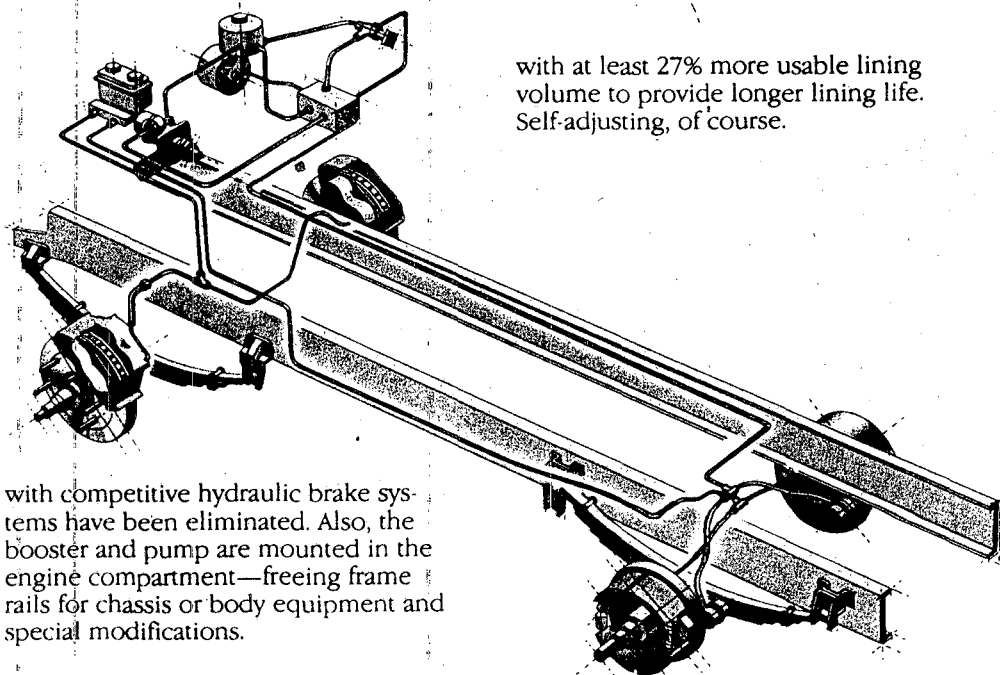

with competitive hydraulic brake systems have been eliminated. Also, the booster and pump are mounted in the engine compartment—freeing frame rails for chassis or body equipment and special modifications.

Total Truck comfort

For years Ford has been a leader in building truck cabs with a driver-centered philosophy. The driver is focal point of engineering, design and function.

Ford first introduced the famous "Driverized Cab." A great step forward in this field. Today it's called ergonomics—the science involving the interior design of the vehicle for driver convenience and comfort. The Ford F-Series cab is definitely designed to put the driver in full command. Instruments are easy to read, controls easy to reach.

The spacious interior is clean and clear in the floor area, too. The heater/optional air conditioning units are outside the cab in the engine compartment. The foot parking brake pedal or parking hand lever have been eliminated on hydraulic brake models with the new parking brake knob on the instrument panel. Also, the ignition switch is located on the steering column, as is the optional automatic transmission lever. Power steering is standard for handling and maneuvering ease. And the large windshield plus hood design provide good forward sight lines. In addition to all this, you have your choice of two cab trim levels.

Custom Hi-Level Trim. Great looking, as shown at left, with great comfort and convenience, the attractive top-of-the-line trim level features: Door panels of color-keyed plastic with brushed aluminum insert, bright molding, and carpeting on lower portion of panel. Color-keyed headliner trim and garnish moldings. Polyknit vinyl seat trim—color-keyed in Charcoal or Tan.

Standard Cab exterior features include: Painted western mirrors with auxiliary convex mirrors. Bright windshield molding. Two-speed electric windshield wipers and washers. Halogen headlamps. Dual cab assist handles.

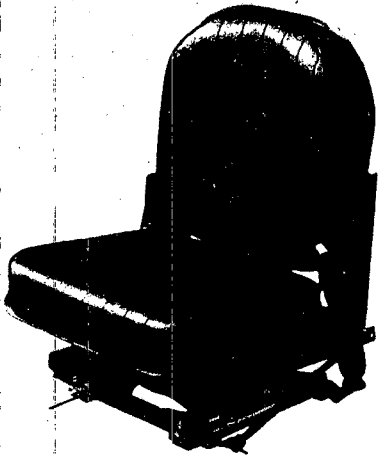
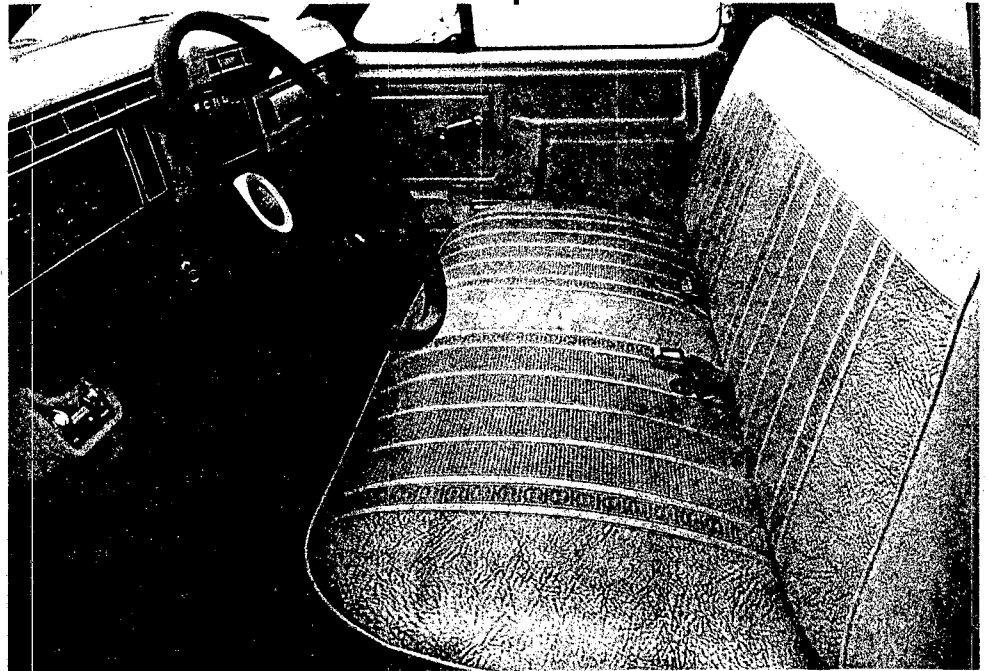

Individual seating comfort.

Boström Viking T-Bar driver and passenger seats* are optional. These individual seats are attractively trimmed in black vinyl.

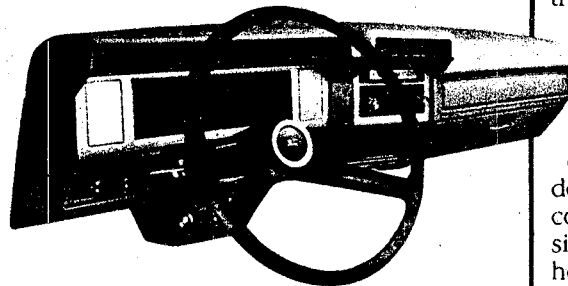

Easy-to-read instrumentation. The attractive F-Series instrument panel is designed for easy viewing and convenient location of controls.

Standard Cab Interior. The value-packed Standard Cab, shown above, has all of these features: All-vinyl seat trim in two colors—Charcoal or Tan.

Seat has five inches of foam padding over Flex-O-Lator springs. Color-keyed door panels. Armrests with integral door latch handle. Reversible key locks. Deluxe instrument cluster on black panel. Glove box door with horizontal hold position and coin/token slots plus two-cup depressions on the inner side. Ashtray. Coat hook. Dome light. Door courtesy light switches. Left sun visor.

Galion®

Models 401 U/401 F

Standard Lengths - 8, 9, 10 ft.

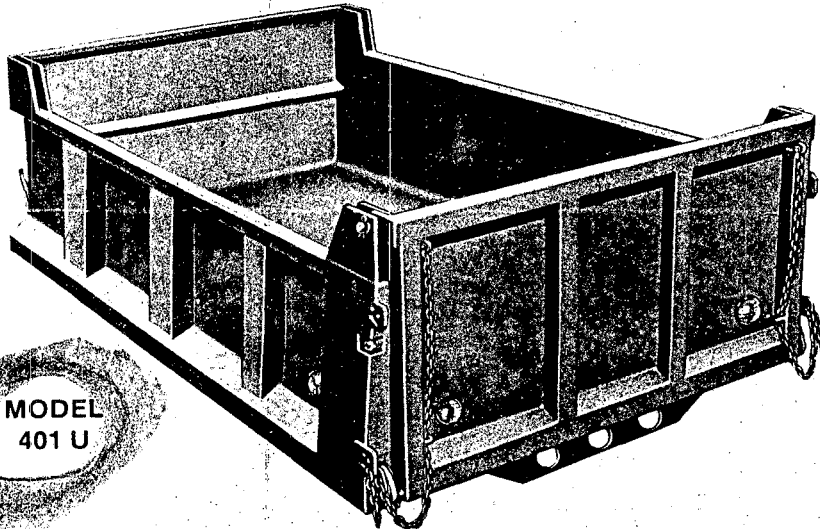

MODEL
401 U

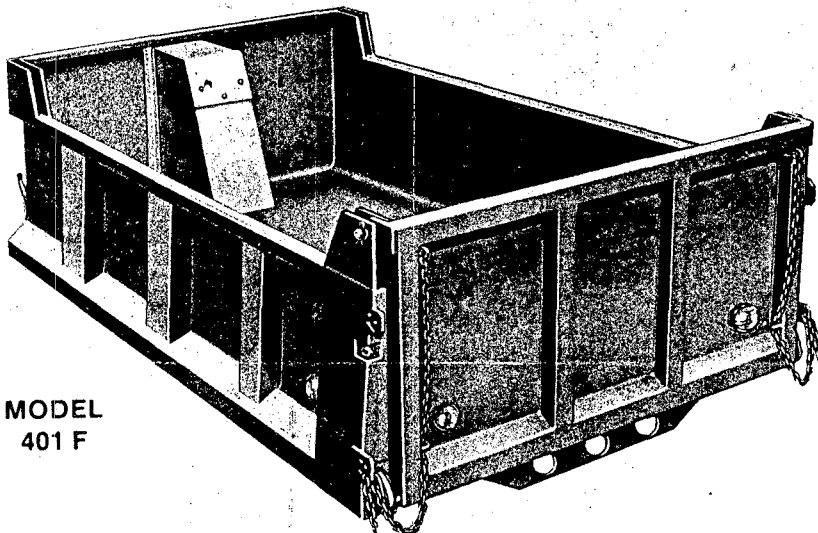

MODEL
401 F

All Galion 401 Series bodies utilize hi-resistant steel throughout for increased resistance to abrasion and shock loading. Extremely strong understructure gives these units added stability for loading. Designed for general construction and batch work under normal loading and hauling conditions. Ideal for spreading stone, gravel, and other aggregates. Particularly well suited to municipality and highway construction and maintenance. Depend on Galion dump bodies for high-volume performance all the way. Recommended for single axle applications on trucks having 60", 72" and 84" cab-to-axle dimension. Available with underbody or telescopic hoist.

SPECIFICATIONS OTHER SIDE

ALL WELDED
CONSTRUCTION

TAPERED BOX
SIDE BRACES

DOUBLE-ACTING
TAILGATE

SLOPING
RUBRAILS

CHANNEL
UNDERSTRUCTURE

HIGH-RESISTANT
STEEL

2-INCH SIDE-
TO-FLOOR RADIUS

CONTRACTOR MODEL

Peabody Galion
Material Handling Products

Galion®

Models U-740 C U-740 C-DA

For Single Axle Trucks

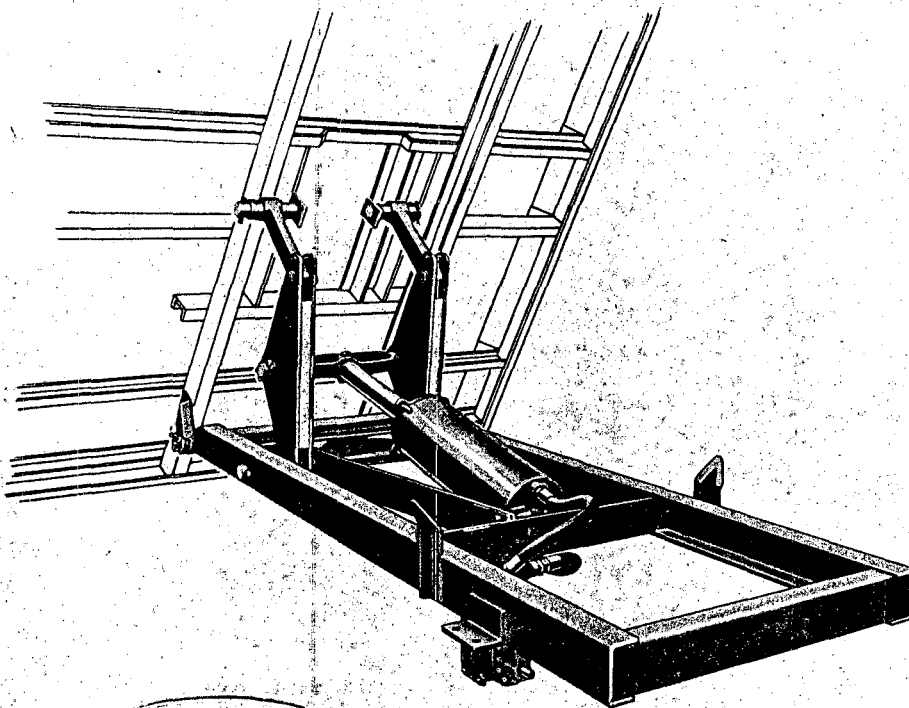

MODEL U-740 C

Easiest Lifting for Heavy Loads — Long stroke with high displacement cylinder along with dual steel plate lift arms and solid steel lift links mounted in a heavy channel subframe using Galion's unique tie bar construction provides smooth, high capacity at all times. Full rear hinge shaft with heavy steel plate hinges provide extra stability and added strength to rear chassis frame. Municipal type hoist for bodies 8, 9 and 10 feet in length with 60, 72 and 84 inch cab-to-axle chassis.

SPECIFICATIONS OTHER SIDE

ONE BODY PROP
AND CONTROL
LOCKING DEVICE

DUAL STEEL PLATE
LIFT ARMS

RUGGED
HINGES

PRECISION HONED
SEAMLESS STEEL
CYLINDERS

SOLID
STEEL
LIFT LINKS

THROUGH
PIVOT SHAFT

LOW
MAINTENANCE

NEEDLE-BEARING
GEAR PUMP

DEPENDABLE

Peabody Galion
Material Handling Products

SPECIFICATIONS

Models U-740 C U-740 C-DA

QUALITY CONTROL ASSURES TOP QUALITY

	U-740 C	U-740 C-DA
Recommended Longitudinals	5" — 6.7 lb. Channel	5" — 6.7 lb. Channel
Recommended Crossmembers	4" Channel	4" Channel
HOIST		
Max. lifting capacity*	31,000 lbs.	31,000 lbs.
Subframe	1/4" steel channel	1/4" steel channel
Pivot shaft	Full single	Full single
Mounting Height	14 1/2 ins.	14 1/2 ins.
Standard Pivot	12 ins.	12 ins.
Standard Dump Angle	50°	50°
Weight**	850 lbs.	880 lbs.
Oil Capacity	4.1 Gal.	5.6 Gal.
CYLINDER		
Bore	7.00 ins.	7.00 ins.
Stroke	20 3/8 ins.	20 3/8 ins.
Displacement	784 cu. ins.	784 cu. ins.
Casing Wall Thickness (Nominal)	.384 in.	.384 in.
Number of Piston Rings	3	3
Piston Rod Diameter	2.50 ins.	3.00 ins.
COMBINATION PUMP		
Model	107-CA	100
Delivery	12.7 G.P.M.	12.7 G.P.M.
Shaft Diameters	13/16 in.	13/16 in.
Gear Length	1.00 in.	1.00 in.
Valve Type	4 position spool	3 position spool

U-740 C-DA

Specifications same as above but includes "power down" feature.

* Governed by body length & pivot

** Includes all mounting equipment

FOUR POSITION VALVE . . .

The Galion four-position valve offers a "raise," a "hold," and two lowering positions. The normal "lower" position allows you to let down an empty body fast and the "feather" position lets you lower a loaded body slowly without damage to the chassis or hoist.

CONTROLS . . .

Lever or cable. Galion hoist controls are designed for your truck. Lever controls for mounting on the floor are standard equipment. Optional cable controls are for dash mounting. (Not available on D.A. Hoist.)

Peabody reserves the right under its Product Improvement Program to modify construction and/or design details and furnish equipment when so altered without reference to illustrations and/or specifications shown herein. All specifications subject to change without notice.

**FULL FACTORY WARRANTY
COMPLETE PARTS AND SERVICE AVAILABLE
THROUGH NATIONWIDE AUTHORIZED DISTRIBUTORS**

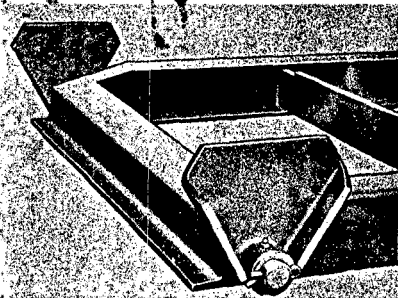

STEEL PIVOT HINGES and through pivot shaft provide dumping stability and have lubricated bearing surfaces to minimize wear.

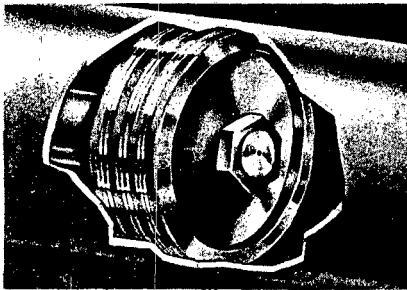

CYLINDER WALLS HONED to a mirror finish, large diameter piston rods, heavy piston heads, and cast iron rings mean a dependable long life.

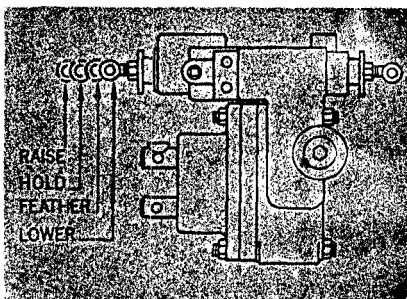

THE GALION FOUR-POSITION VALVE offers two lowering speeds to allow lowering of a heavy load gently, or an empty body quickly. (U-740C)

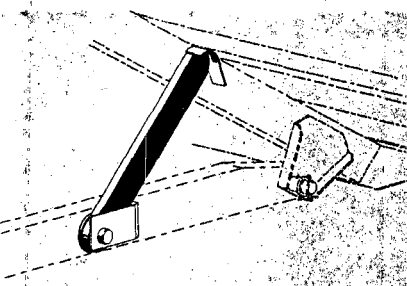

BODY PROP provides a positive means of support and is locked in position to prevent accidental lowering of body during maintenance or inspection.

Authorized Distributor:

Peabody Galion

Material Handling Products
P.O. Box 607 | Galion, Ohio 44833-0607
419 468-2120

WHEELER TRUCK BODY & EQ, INC.
500 SOUTH FOURTH STREET
BEAUMONT, TEXAS 77701
(713) 832-8407

ALLISON CHEVROLET, INC.
HIGHWAY 69
COLMESNEIL, TEXAS 75938

VOL 009 PAGE 44

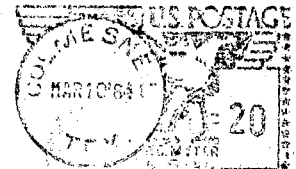

1 9 8 4 • C H E V R O L E T

For Three Trucks

County of Tyler
100 Courthouse
Woodville, Texas 75979

NO. _____ TIME: 9:30 AM PM

MAR 12 1984



CHEVROLET
taking charge.

GRACE BOSTICK, COUNTY CLERK
TYLER COUNTY, TEXAS
BY: *Grace Bostick*

1 9 8 4 - C H E V R O L E T

ALLISON CHEVROLET, INC.
HIGHWAY 69 P. O. BOX 460
COLMESNEIL, TEXAS 75938

VOL 009 PAGE 45

March 10, 1984

County of Tyler
100 Courthouse
Woodville, Texas 75979

Dear Sirs:

Allison Chevrolet, Inc. submits the following bid on the three (3) Dump Trucks with the equipment as specified:

1984 Chevrolet C7D042 - $3\frac{1}{2}$ Ton
18,500 # 2-Speed Rear End - Eaton
1000 x 20 Tires Highway Front - 12 Ply
1000 x 20 Tires on/off Rear - 12 Ply
Wheels - 10 Hole Budd
366 Cu. Inch Engine
5 Speed Transmission - Clark or New Process (Spicer n/a on this Engine)
Hydraulic Brakes
Regular Cab W/Heater
All Instruments
Heavy Duty Cooling
Reinforced (Inverted L) Frame
119" Wheel Base (84" Cab to Axle)
23,000 lbs. Rear Springs
Multileaf Auxiliary Springs
Power Steering
50 Gal Saddle Tank
Dual 6 x 16 Mirrors
9000 Front Axle

\$15,456.94 x 3 = 46,370.82

The same truck with air brakes and 13 Cu. Foot air tank

\$16,540.35 x 3 = 49,621.05



CHEVROLET
taking charge.

1 9 8 4 - C H E V R O L E T

ALLISON CHEVROLET, INC.
HIGHWAY 69 P. O. BOX 460
COLMESNEIL, TEXAS 75938

VOL 009 PAGE 46

A 10' long 6 yard water level and 8 yard dump bed, installed, painted, with half cab protector, mud flaps, warning horns, and lights will be:

\$3,695.00 each

The total price of the trucks with beds:

With hydraulic brakes: \$19,151.94 x 3 = 57,455.82

With air brakes: \$20,235.35 x 3 = 60,706.05

The above prices are good for orders taken prior to March 31, 1984.
Please advise if additional information is needed.

Sincerely yours,

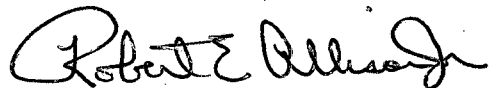

Robert E. Allison, Jr.
President

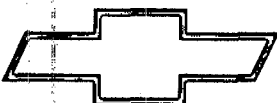

CHEVROLET
taking charge.



A & M MOTOR CO., INC.

P. O. BOX 509

605 SOUTH MAGNOLIA

PHONE (713) 283-2534

WOODVILLE, TEXAS 75979



PONTIAC

VOL 009 PAGE 47

March 7, 1984

F. M. ARCHER, President
VERA F. OGDEN, Secretary-Treasurer



County of Tyler
100 Courthouse
Woodville, Texas 75979

Gentlemen:

We appreciate the opportunity to bid on your trucks. All specifications have been met or exceeded. I have also included alternate bids with Clark transmission and Firestone Disc Wheels which are less expensive than Budd (but of the same quality).

The bids are on attached sheet.

Yours very truly,

Forrest M. Archer, Jr.

/o

Att.

Handwritten note:
All →
Saw

BID NO. 1

1984 GMC, 7000 Series
 366 V8 Engine
 H. D. Radiator
 50 Gal. Step Tank
 Dual Exhaust
 Spicer Transmission
 19,000 lb. 2 Speed Axle
 23,000 lb. Rear Suspension
 Aux. Rear Springs
 Budd Wheels - Ft. & RR 10 Hole
 On-Off Road Rear Tires 10.00 x 20 12 ply
 9,000 lb.Ft. Axle
 9,000 lb.Ft. Springs
 Reinforced Frame
 Hydraulic Brakes
 149" Wheelbase, 84" Cab to Axle

VOL 009 PAGE 48

Price of 1 Unit \$15,900.00 x 3 = \$47,700.00
 "Heil" Dump Bed
 as specified \$ 3,650.00 x 3 = \$10,950.00
 TOTAL PRICE.... \$19,550.00 x 3 = \$58,650.00

BID NO. 2

Same specifications as Bid No. 1 EXCEPT:
 Clark 5 Speed Transmission
 Firestone Eheels, Disc 10 Hole Ft. & RR

Price of 1 Unit \$14,650.00 x 3 = \$43,950.00
 "Heil" Dump Bed \$ 3,650.00 x 3 = \$10,950.00
 TOTAL PRICE.... \$18,300.00 x 3 = \$54,900.00

BID NO. 3

Same specifications as Bid No. 1 EXCEPT:
 Air Brake System (This unit has Spicer Trans., Budd Wheels)

Price of 1 Unit \$16,800.00 x 3 = \$50,400.00
 "Heil" Dump Bed \$ 3,650.00 x 3 = \$10,950.00
 TOTAL PRICE.... \$20,450.00 x 3 = \$61,350.00

BID NO. 4

Same specifications as Bid No. 1 EXCEPT:
 Clark 5 Speed Transmission
 Air Brake System
 Firestone Disc Wheels 10 Hole FT.& RR

Price of 1 Unit \$16,375.00 x 3 = \$49,125.00
 "Heil" Dump Bed \$ 3,650.00 x 3 = \$10,950.00
 TOTAL PRICE.... \$20,025.00 x 3 = \$60,075.00

BY A & M MOTOR CO., INC.

BY Forrest M. Archer, Jr.
 Forrest M. Archer, Jr.

A & M MOTOR CO., INC.

P. O. BOX 509

WOODVILLE, TEXAS 75979-0509

VOL 009 PAGE 49

NO. _____ TIME: 9:50 AM

MAR 8 1984

GRACE BOSTICK, COUNTY CLERK
TYLER COUNTY, TEXAS

BY: *Wanda Dehner*

BID County
TRUCKS

FOR 3-12-84

COUNTY OF TYLER
100 COURTHOUSE
WOODVILLE, TEXAS

75979

INTERNATIONAL PAPER COMPANY

2800 WODEN ROAD

P.O. BOX 987

NACOGDOCHES, TEXAS 75963-0987

PHONE (713) 564-8375

VOL 009 PAGE 50

TO County Judge of Tyler County
Woodville, Texas 75979

DATE March 19, 1984

SUBJECT 82: Tex. L/L 229-27
Tyler Co. Historical Soc.

Gentlemen:

Attached, please find fully executed amendment to the above listed lease.

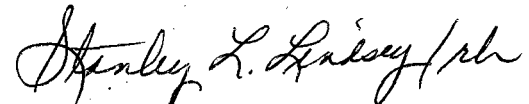

STANLEY L. LINDSEY, Mgr.
Fredonia Land & Timber

SLL:rb
Atch.

KNOW ALL MEN BY THESE PRESENTS that, for and in consideration of the mutual understandings, undertakings, considerations to be paid and received, and the terms and conditions hereinafter set forth, it is UNDERSTOOD and AGREED by and between International Paper Company, a corporation, and Tyler County, Texas that by land lease 82: Tex. L/L #229-27, executed by and between the parties hereto on the 20th day of April, 19 71, be and the same hereby is, amended as follows:

The land lease is extended for a one (1) year period, making expiration date April 30, 1985.

There is no consideration.

All other terms and conditions are to remain the same.

Except as altered, modified and amended to the extent and in the particulars hereinbefore set out, the said parties do hereby ratify and confirm all and singular the other provisions of the aforesaid land lease

IN WITNESS WHEREOF, the parties hereto have caused this instrument to be duly executed in duplicate original counterparts on this 19th day of March, 19 84.

INTERNATIONAL PAPER COMPANY, a Corporation

By Stanley S. Lindsey (Title) Mgr. Fredonia Land & Timber

WITNESSES:

Robbie Brudwell

Ray Howard

WITNESSES:

X Wanda F. Johnston

X Jean Phillips

TYLER COUNTY, TEXAS

By: [Signature] (Title) County Judge of Tyler County

THIS INSTRUMENT WAS RECEIVED FOR RECORDING IN OUR OFFICE IN THIS COUNTY

COMMISSIONER'S COURT OF March 16, 1984 Page 14 of 14
 CLAIM REGISTER AND MINUTES OF ACCOUNTS ALLOWED, _____ FUND TYLER COUNTY, TEXAS

Claim Number	NAME OF CLAIMANT	NATURE OF CLAIM	Amount of Claim	Da Allo
	<u>JUVENILE PROBATION:</u>			
25632	Rogers Office Supply	Office Supplies	\$ 9.75	
25635	Southwestern Bell Telephone	Telephone	35.35	
25636	Direct Dialing System	Long Distance Calls	1.44	
25512	Deep East Tex. Workers Comp.	March Premium	7.60	15.54
	<u>CAPITAL IMPROVEMENT</u>			
25562	Crocker Plumbing & Water Wells	Repairs to Plumbing	57.50	15.54
	<u>LAW LIBRARY:</u>			
25647	Southwestern Bell	Telephone	22.84	15.54

APPROVED THIS 16th day of March, 1984
Allen Brown
 COUNTY JUDGE

CLAIMS CHECKED AND APPROVED
Ann Nibel
 COUNTY AUDITOR

COMMISSIONER'S COURT OF March 16, 1984

Page 13 of 14

CLAIM REGISTER AND MINUTES OF ACCOUNTS ALLOWED, TCDBG (HUD GRANT) FUND TYLER COUNTY, TEXAS

Claim Number	NAME OF CLAIMANT	NATURE OF CLAIM	Amount of Claim	Date Allowed
HUD-1	Everett Griffith, Jr. & Assoc.	Engineering Services	\$4594.15	
HUD-2	East Tex. Testing Laboratory, Inc.	Soil Testing	1700.00	
HUD-3	Transfer to Road & Bridge I	Reimbursement for Opening Account	100.00	
HUD-4	Tyler County Booster	Legal Public Notice	137.76	
HUD-5	Deep East Tex. Council of Govts.	Administrative Services 12-1-83 - 2-29-84	651.53	
HUD-6	The Woodsman	Public Notice re Environ. Impact	96.78	
<u>FEDERAL REVENUE SHARING - SOLID WASTE</u>				
1765-a	Deep East Tex. Workers Comp.	March Premium	112.93	
1772-a	J.E. Gardner Oil	Fuel	352.00	
1771-a	Birdwells Welding & Machine Shop	Repairs to Equipment	9.51	
1770-a	Gulf Welding Supply	Oxygen & Supplies	66.50	
1769-a	George P. Bane	Repairs to 750 J. Deere	1135.48	
1768-a	Woodville Auto Parts	Anti-Freeze	25.50	
<u>ADULT PROBATION:</u>				
25636	Direct Dialing System	Long Distance Calls	2.81	
25635	Southwestern Bell Telephone	Telephone	17.33	
25634	Tex. Dist. & Co. Attys. Assoc.	Law Books	9.45	
25633	Rogers Office Supply	Office Supplies	41.36	

APPROVED THIS 16th day of March, 1984

COUNTY JUDGE

CLAIMS CHECKED AND APPROVED

COUNTY AUDITOR

COMMISSIONER'S COURT OF March 16, 1984

Page 12 of 14

CLAIM REGISTER AND MINUTES OF ACCOUNTS ALLOWED, Road & Bridge IV FUND TYLER COUNTY, TEXAS

Claim Number	NAME OF CLAIMANT	NATURE OF CLAIM	Amount of Claim	Da Allc
25512	Deep East Texas Workers Comp.	March Premium	\$ 454.65	
25521	Gulf States Utilities	County Barn Utilities	58.94	
25520	Southwestern Bell Telephone	County Barn Telephone	21.64	
25525	George P. Bane	Repairs to Equipment	1203.13	
25262	Woodville Auto Parts, Inc.	"	1796.62	
25651	Spurger Gulf Station	Parts & Fuel	182.48	
25524	J.E. Gardner Oil	Fuel	2084.68	
25519	Gulf Oil Corporation	Fuel	20.00	
25637	Holdermans Building Center	Plastic Pipe (Signed by Odom)	31.00	
25522	Jasper Creosoting Co.	Bridge Timber	1112.83	
25523	Freemans	Culverts	2378.82	
25526	Gulf Welding Supply	Oxygen	18.00	
				\$93

APPROVED THIS 16th day of March, 1984
Allen Hancock
 COUNTY JUDGE

CLAIMS CHECKED AND APPROVED
Ann Michel
 COUNTY AUDITOR

COMMISSIONER'S COURT OF March 16, 1978 84 Page 11 of 14
 CLAIM REGISTER AND MINUTES OF ACCOUNTS ALLOWED, R&B III Continued FUND TYLER COUNTY, TEXAS

Claim Number	NAME OF CLAIMANT	NATURE OF CLAIM	Amount of Claim	Date Allowed
25623	J.W. Marshall	Dragline Work	\$3270.00	
25627	Tyco Feed Company	Weight Tickets	4.00	
25630	Holdermans Building Center	Spikes	91.42	
25628	Lehmans Pipe & Steel, Inc.	Metal Pipe	208.69	
25629	Goodyear	Tires	572.60	
25636	Direct Dialing Systems	Telephone, Long Distance	.58	
25512	Deep East Texas Workers Comp.	March Premium	385.10	

\$18,05

APPROVED THIS 16th day of March, 1978 84
[Signature]
 COUNTY JUDGE

CLAIMS CHECKED AND APPROVED
[Signature]
 COUNTY AUDITOR

COMMISSIONER'S COURT OF March 16, 19784Page 10 of 14CLAIM REGISTER AND MINUTES OF ACCOUNTS ALLOWED, Road & Bridge III FUND TYLER COUNTY, TEXAS

Claim Number	NAME OF CLAIMANT	NATURE OF CLAIM	Amount of Claim	Date Allowed
25631	Justin Equipment	Parts	\$ 105.77 /	
25619	Allison Chevrolet, Inc.	Parts & Labor	633.66 /	
25610	Gibbs Motor Company	Repairs to Equipment	953.69 /	
25608	C&M Repair Services	"	129.30 /	
25644	Mustang Tractor	"	519.96 /	
25616	Jimmys Auto Parts	"	52.37 /	
25614	Hyco Equipment, Inc.	"	87.53 /	
25613	A-Z Discount Parts, Inc.	"	85.77 /	
25609	A&H Asphalt Company	Asphalt	521.88 /	
25626	Martins True Value Hardware	Hardware	24.55 /	
25624	Sullivans Hardware	Drill Bits	11.88 /	
25643	Thornton Hardware	Nails	80.60 /	
25653	Airco Welding	Oxygen & Supplies	26.15 /	
25611	Colmesneil Telephone Co.	Telephone	70.70 /	
25618	Hills Hollow	Fuel	19.85 /	
25621	Jasper Oil Company	Diesel	873.33 /	
25622	Hensarling Auto Service	Diesel	220.60 /	
25612	J.E. Gardner Oil Co.	Fuel	2211.80 /	
25615	Freemans	Culverts	2269.39 /	
25617	Streets Pest Control	Exterminating Office & Shop	125.00 /	
25625	Hart Creosoting Co.	Bridge Timbers	1989.96 /	
25620	Jasper Creosoting Co.	"	1503.94 /	

CONTINUED:

APPROVED THIS 16th day of March, 19784

Allen [Signature]
 COUNTY JUDGE

CLAIMS CHECKED AND APPROVED

[Signature]
 COUNTY AUDITOR

COMMISSIONER'S COURT OF March 16, 1984

Page 9 of 14

CLAIM REGISTER AND MINUTES OF ACCOUNTS ALLOWED, Road & Bridge II FUND TYLER COUNTY, TEXAS

Claim Number	NAME OF CLAIMANT	NATURE OF CLAIM	Amount of Claim	Da Allo
25512	Deep East Texas Workers Comp.	March Premium	\$ 245.77 /	
25604	Mustang Tractor & Equipment	Repairs to Equipment	297.80 /	
25603	C&M Repair Service	"	426.93 /	
25601	Woodville Auto Parts	"	240.51 /	
25599	Durham Electric	"	33.50 /	
25600	Jasper Creosoting Company	Creosoted Timbers	1932.00 /	
25602	J.E. Gardner Oil	Gas	1508.88 /	
25605	Sam Houston Electric Co-Op	County Barn Utilities	14.59 /	
25606	Sullivans Hardware	Wire Brushes	4.78 /	
25607	A&H Asphalt Company	Pre-Mix	927.05 /	

#563

APPROVED THIS 16th day of March, 1984
[Signature]
 COUNTY JUDGE

CLAIMS CHECKED AND APPROVED
[Signature]
 COUNTY AUDITOR

COMMISSIONER'S COURT OF March 16, 1984Page 8 of 14CLAIM REGISTER AND MINUTES OF ACCOUNTS ALLOWED, Road & Bridge I FUND TYLER COUNTY, TEXAS

Claim Number	NAME OF CLAIMANT	NATURE OF CLAIM	Amount of Claim	D All
25512	Deep East Texas Work. Comp.	March Permium	\$ 315.32	
25580	Geo. P. Bane Inc.	Parts	2,523.43	
25581	Mustang Tractor	Battery	121.35	
25583	Etox, Inc.	Welding Supplies	17.95	
25584	Knapp Ford Sales	Parts	1.91	
25585	Jerry's Exxon Station	Saw Repairs	34.80	
25586	C&M Repair Service	Repairs to Equip.	318.00	
25589	Jo-Be Equip.	Parts	9.79	
25593	A-Z Discount Auto Parts	Parts	9.15	
25594	Woodville Auto Parts	Parts & Labor	725.03	
25592	Davis Food Market	Gas	47.40	
25590	Jackson Petroleum	Fuel & Oil	1,584.85	
25591	Greenwood Exxon	Tire Repair	75.00	
25532	Goodyear	Tires	217.08	
25595	A & H Asphalt Co.	Pre-Mix	920.64	
25588	Freeman's	Culverts & Hand Soap	965.04	
25596	Gulf States Utilities Co.	Utilities @ Co. Barn	52.52	
25587	Seneca Water Supply Co.	Water @ Co. Barn	8.50	
25518	Sullivans Hardware	Supplies	11.76	
25597	Holderman's Building Center	3 Shovels	20.68	
25582	South Magnolia Groc.	Ice	19.80	
			Tot. 3000.00	

APPROVED THIS 16th day of March, 1984

COUNTY JUDGE

CLAIMS CHECKED AND APPROVED

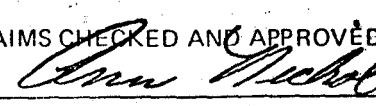

COUNTY AUDITOR

COMMISSIONER'S COURT OF March 16, 1978 Page 7 of 14
 CLAIM REGISTER AND MINUTES OF ACCOUNTS ALLOWED, GENERAL FUND TYLER COUNTY, TEXAS

Claim Number	NAME OF CLAIMANT	NATURE OF CLAIM	Amount of Claim	Da Allo
25649	Office Supply Center	Office Supplies	\$ 57.50	
25636	Direct Dialing	Telephone	1.98	
25639	Southwestern Bell	Telephone	29.82	
		<i>Tot. U.A.</i>	<i>89.30</i>	
25649	Office Supply Center	Office Supplies	12.07	
25639	Southwestern Bell	Telephone	158.58	
		<i>Tot TRIPS.</i>	<i>170.65</i>	
25639	Southwestern Bell	Telephone	79.49	
25579	Rogers Office Supply	Office Supplies	2.16	
		<i>Tot EXT.</i>	<i>81.65</i>	
25639	Southwestern Bell	AIRPORT-Telephone	14.83	
25576	Mrs. Duvall Mixon	FOSTER CHILD CARE-M. & T. Lorenz	507.00	
25531	Brookshire Bros.	CONCERNED CITIZENS-Food to Needy	128.26	
25659	Kinney & Owens, Attys.	Court Appt'd re R. Henry	168.75	
25660	Robert H. Mann, Atty.	Court Appt'd re J.P. Kelley	251.72	
		<i>Tot. GEN. FUND</i>	<i>47,398.92</i>	

APPROVED THIS 16th day of March, 19784
[Signature]
 COUNTY JUDGE

CLAIMS CHECKED AND APPROVED
[Signature]
 COUNTY AUDITOR

COMMISSIONER'S COURT OF March 16, , 1984

Page 6 of 14

CLAIM REGISTER AND MINUTES OF ACCOUNTS ALLOWED, GENERAL FUND TYLER COUNTY, TEXAS

Claim Number	NAME OF CLAIMANT	NATURE OF CLAIM	Amount of Claim	Da Allow
25579	Rogers Office Supply	Office Supplies	\$ 26.12	
25578	Lufkin Typewriter	Office Supplies	43.50	
25571	Bennett Printing Co.	Forms	16.01	
25649	Office Supply Center	Office Supplies	24.65	
25639	Southwestern Bell	Telephone	103.31	
25636	Direct Dialing Systems	Telephone	6.05	
		<i>Tot. SPI</i>	<i>219.64</i>	
25639	Southwestern Bell	Telephone	20.63	
		<i>Tot. SPII</i>	<i>20.63</i>	
25568	Colmesneil Telephone Co.	Telephone	26.05	
25636	Direct Dialing	Telephone	3.74	
		<i>Tot. SPIII</i>	<i>29.79</i>	
25639	Southwestern Bell	Telephone	42.32	
		<i>Tot. SPIV</i>	<i>42.32</i>	
25579	Rogers Office Supply	Office Supplies	36.81	
25649	Office Supply Center	Office Supplies	41.91	
25636	Direct Dialing	Telephone	1.10	
25639	Southwestern Bell	Telephone	53.76	
		<i>Tot. DIST CLERK</i>	<i>133.58</i>	
25639	Southwestern Bell	Telephone	52.29	
25636	Direct Dialing	Telephone	3.34	
25579	Rogers Office Supply	Office Supplies	53.10	
25649	Office Supply Center	Office Supplies	82.68	
		<i>Tot AUDITOR</i>	<i>191.41</i>	

APPROVED THIS 16th day of March, 1984

COUNTY JUDGE

CLAIMS CHECKED AND APPROVED

COUNTY AUDITOR

COMMISSIONER'S COURT OF March 16, 1984

Page 5 of 14

CLAIM REGISTER AND MINUTES OF ACCOUNTS ALLOWED, GENERAL FUND TYLER COUNTY, TEXAS

Claim Number	NAME OF CLAIMANT	NATURE OF CLAIM	Amount of Claim	Da Allo
25579	Rogers Office Supply Co.	Office Supplies	\$ 114.86	
25648	McClung Law Books, Inc.	Lawyers Handbook	41.00	
25645	West Publishing Co.	Law Book	17.00	
25646	Lufkin Typewriter	Office Supplies	43.50	
25639	Southwestern Bell	Telephone	37.84	
		<i>Tot. Co. ATTY</i>	<i>254.20</i>	
25639	Southwestern Bell	Telephone	123.02	
25636	Direct Dialing Systems	Telephone	6.51	
25349	Office Supply Center	Office Supplies	37.91	
25579	Rogers Office Supply	Office Supplies	2.85	
25645	West Publishing Co.	Law Book	14.00	
		<i>Tot. DIST ATTY</i>	<i>184.29</i>	
25638	Joe R. Smith, Atty.	Court Appt'd re T.D. Redmon	150.00	
25636	Direct Dialing Systems	Telephone	.49	
25639	Southwestern Bell	Telephone	58.71	
		<i>Tot. DIST COURT</i>	<i>209.20</i>	
25554	Stafford-Lowdon	Printed Forms	450.91	
25555	Great Western Supply	Office Supplies	59.90	
25579	Rogers Office Supply	Office Supplies	26.05	
25639	Southwestern Bell	Telephone	78.43	
		<i>Tot. Co. CLERK</i>	<i>615.29</i>	
25517	Kinney & Owens	Cain VS Tyler County Expenses	19.83	

Tot. Co. COURT 19.83

APPROVED THIS 16th day of March, 1984

John D. Brown
COUNTY JUDGE

CLAIMS CHECKED AND APPROVED
Ann Michel
COUNTY AUDITOR

COMMISSIONER'S COURT OF March 16, , 1984

Page 4 of 14

CLAIM REGISTER AND MINUTES OF ACCOUNTS ALLOWED, GENERAL FUND TYLER COUNTY, TEXAS

Claim Number	NAME OF CLAIMANT	NATURE OF CLAIM	Amount of Claim	Date Allowed
25636	Direct Dialing Systems	Telephone	\$ 2.15	
25639	Southwestern Bell	Telephone	48.42	
25528	Wal-Mart	Electric Broom	33.86	
25559	Mattingly Printing	Information Cards	65.00	
25527	City of Woodville	Utilities	101.55	
25577	Jackson Petroleum	Gas-Mini-Bus	86.06	
25575	Hensarling Auto Service	Oil-Mini-Bus	1.84	
25558	Wal-Mart	Oil-Mini-Bus	8.70	
25556	Transfer to R&B #1	Gas-Mini-Bus	177.41	
		<i>Tot. Ageing</i>	<i>524.99</i>	
25649	Office Supply Center	Office Supplies	24.55	
25559	Mattingly Printing	Pct. Maps & Envelopes	49.50	
25639	Southwestern Bell	Telephone	176.14	
25636	Direct Dialing Systems	Telephone	15.34	
		<i>Tot. Co. Judge</i>	<i>265.53</i>	
25649	Office Supply Center	Office Supplies	18.17	
25646	Lufkin Typewriter	Office Supplies	11.00	
25639	Southwestern Bell	Telephone DPS-64.89, P&W-24.82	89.71	
25636	Direct Dialing Systems	Telephone DPS*	1.33	
		<i>Tot. DPS</i>	<i>120.21</i>	

APPROVED THIS 16th day of March, 1984

Allen Brantley
COUNTY JUDGE

CLAIMS CHECKED AND APPROVED

Allen Brantley
COUNTY AUDITOR

COMMISSIONER'S COURT OF March 16, 1984Page 3 of 14CLAIM REGISTER AND MINUTES OF ACCOUNTS ALLOWED, GENERAL FUND TYLER COUNTY, TEXAS

Claim Number	NAME OF CLAIMANT	NATURE OF CLAIM	Amount of Claim	D
25579	Rogers Office Supply	Office Equip-File Cabinet-Co.Atty.	\$ 720.00	
25579	Rogers Office Supply	Office Equip-File Cabinet-Tax Off.	175.00	
25649	Office Supply Center	Office Equip-Work Table-JP#I	54.10	
5646	Lufkin Typewriter	Office Equip-Typewriter-JP#I	864.00	
		<i>Tot. MISC.</i>	<i>14,835.15</i>	
25637	Holderman's Building Center	Lumber for Bench Repair	5.90	
25529	Sullivans Hardware	Janitors Supplies	58.30	
25530	Brookshire Bros.	Janitors Supplies	139.38	
25574	Consolidated Marketing	Restroom Supplies	133.39	
25561	Shepherd's Linen Supply	Janitors Uniforms	38.60	
25654	Street's Termite & Pest Control	Exterminating for Termites	400.00	
25564	City of Woodville	Courthouse Utilities	1,660.16	
		<i>Tot. BLDG. MAINT.</i>	<i>2435.73</i>	
25573	Barbara Tolbert	Reimb. Auto Acct. for Printed Cks.	17.80	
25572	Western Data Services	Repts., Tax Roll, Equip. Lease	4,063.41	
25570	Barbara Tolbert	Reimb. Tax Acct. on Printed Cks.	19.18	
25579	Rogers Office Supply	Office Supplies	141.22	
25639	Southwestern Bell	Telephone	103.91	
25636	Direct Dialing Systems	Telephone	.14	
		<i>Tot. TAX OFFICE</i>	<i>4,345.66</i>	

APPROVED THIS 16th day of March, 1984

 COUNTY JUDGE

CLAIMS CHECKED AND APPROVED

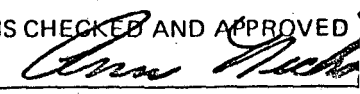

 COUNTY AUDITOR

COMMISSIONER'S COURT OF March 16, 1984

Page 2 of 14

CLAIM REGISTER AND MINUTES OF ACCOUNTS ALLOWED, GENERAL FUND TYLER COUNTY, TEXAS

Claim Number	NAME OF CLAIMANT	NATURE OF CLAIM	Amount of Claim	D All
25539	Bob's Prescription Shop	Photo's	\$ 29.00	
25552	Wal-Mart	Film & Camera	61.76	
25552	Wal-Mart	Coffee Pot-Jail	14.98	
25535	Sumbeam Thrift Store	Bread-Jail	17.00	
25540	South Magnolia Groc.	Bread- ^{Jail} 4.20, Tide & Bleach- ^{Jail} 7.08	11.28	
25579	Rogers Office Supply Co.	Office Supplies	79.87	
25649	Office Supply Center	Office Supplies	45.13	
25646	Lufkin Typewriter	Office Supplies	23.00	
25639	Southwestern Bell	Telephone	395.27	
25636	Direct Dialing Systems	Telephone	24.17	
		<i>Tot. SHERIFF DEPT.</i>	<i>21,538.71</i>	
25516	Monroe Calculator	Service Contract-Tax Office	57.00	
25563	IBM	Service Dontract-Probation	208.66	
25512	Deep East Tex. Workers Comp.	March Permum	714.96	
25534	Woodville Inn	Sesquicentennial Committee Meet. <i>Coffee</i>	23.00	
25567	Tyler County Tax Appraisel Dist.	Second Quarter Payment	11,140.00	
25566	The Woodsman	Adv. re Sale of Sheriff Cars	15.80	
25641	Tyler County Booster	Public Hearing re Dam B Election Advertising Bids re Pct. 1,2, & 4	58.17	
25565	Deep East Tex. Comm. & Jud. Assoc.	Membership Dues (Local 13 Organiz- ation)	600.00	
25560	Deep East Tex. Dev. Assoc.	Membership Dues	145.00	
25635	Southwestern Bell	Telephone-Probation-Service Chg.	60.06	

APPROVED THIS 16th day of March, 1984

Allen Hancock
COUNTY JUDGE

CLAIMS CHECKED AND APPROVED

Ann Michel
COUNTY AUDITOR

COMMISSIONER'S COURT OF March 16, 1984

Page 1 of 14

CLAIM REGISTER AND MINUTES OF ACCOUNTS ALLOWED, GENERAL FUND TYLER COUNTY, TEXAS

Claim Number	NAME OF CLAIMANT	NATURE OF CLAIM	Amount of Claim	Da Allo
25541	Conoco Inc.	Gas	\$ 17.56	
25542	Exxon Co.	Gas	205.52	
25544	Texaco	Gas	153.73	
25545	Gulf Oil	Gas	25.61	
25546	Mobil Oil	Gas	29.02	
25547	Diamond Shamrock	Gas	22.21	
25551	J.E. Gardner Oil	Gas	1,584.33	
25550	Woodville Auto Parts	Repairs to Vehicle	114.78	
25549	The Torque Shop	Repairs to Vehicle	209.00	
25548	Knapp Ford Sales	MVI Sticker	5.25	
25543	Turners Radiator	Repairs to Vehicle	246.02	
25553	Big Thicket Communications	Radio Maint-Feb. & Mar.	406.50	
25537	Tower Specialists, Inc.	Reparis to Radio Tower	135.00	
25642	Allison Chevrolet Inc.	Lease (3) cars @ \$5,765.00 ea.	17,295.00	★
25640	Racal-Milgo	Teletype Maint	155.00	
25650	Spell Cleaners	Cleaning Uniforms	86.35	
25536	John Q. Gilchrist, M.D.	Physical re R. Lee-employee	20.00	
25557	Tyler County Hospital	Medical Assistance re Victim-E. Sears to Murder	41.00	
25538	Brookshire Bros. Pharcacy	RX re Prisoner-R. Wise	23.39	
25533	James M. Brown, M.D.	Medical Expense re Prisoner C. Nix	18.00	
25569	Brian Babin, D.D.S.	Dental Work re Prisoner G. Ross	29.00	
25539	Bob's Prescription Shop	RX re Prisoner-G. Ross	14.98	

APPROVED THIS 16th day of March, 1984

COUNTY JUDGE

CLAIMS CHECKED AND APPROVED

COUNTY AUDITOR